

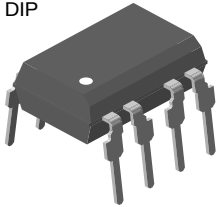

## Telecom Switch 1 Form A Solid-State Relay

DIP



SMD

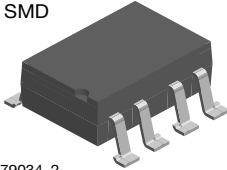

i179034\_2

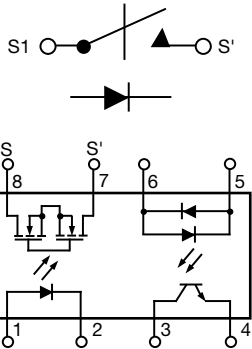

### FEATURES

- Solid-state relay and optocoupler in one package
- Surface-mount package
- I/O isolation, 5300 V<sub>RMS</sub>
- LH1529A, CTR min. = 33 %
- LH1529B, CTR min. = 100 %
- Optocoupler
  - Bidirectional current detection
- Solid-state relay (equivalent to TS117P)
  - Typical R<sub>ON</sub> 20 Ω
  - Load voltage 350 V
  - Load current 120 mA
  - Current limit protection
  - High surge capability
  - Clean bounce free switching
  - Low power consumption
- Material categorization: for definitions of compliance please see [www.vishay.com/doc?99912](http://www.vishay.com/doc?99912)



RoHS COMPLIANT

### DESCRIPTION

The LH1529A and LH1529B telecom switches consist of an optically coupled solid state relay (SSR) and bidirectional input optocoupler. The SSR is ideal for performing switch hook and dial-pulse switching whilst optocoupler performs ring detection and loop current sensing functions. Both the SSR and optocoupler have an isolation test voltage of 5300 V<sub>RMS</sub>.

### AGENCY APPROVALS

- UL1577 (pending)
- BSI / BABT (pending)
- FIMKO (pending)

### APPLICATIONS

- General telecom switching
  - On/off hook control
  - Dial pulse
  - Ring current detection
  - Loop current sensing

### Note

- See "solid-state relays" (application note 56)

ORDERING INFORMATION												
L	H	1	5	2	9	#	#	#	T	R	 DIP	 SMD
PART NUMBER						ELECTR. VARIATION			PACKAGE CONFIG.		TAPE AND REEL	
<b>PACKAGE</b>												
SMD-8, tubes											LH1529AAC	
SMD-8, tape and reel											LH1529ACTR	
SMD-8, tubes											LH1529BAC	
SMD-8, tape and reel											LH1529BACTR	
DIP-8, tubes											LH1529BB	



ABSOLUTE MAXIMUM RATINGS (T <sub>amb</sub> = 25 °C, unless otherwise specified)				
PARAMETER	TEST CONDITION	SYMBOL	VALUE	UNIT
<b>SSR</b>				
<b>INPUT</b>				
LED continuous forward current		I <sub>F</sub>	50	mA
LED reverse voltage	I <sub>R</sub> ≤ 10 μA	V <sub>R</sub>	5	V
<b>OUTPUT</b>				
DC or peak AC load voltage	I <sub>L</sub> ≤ 50 μA	V <sub>L</sub>	350	V
Continuous DC load current		I <sub>L</sub>	120	mA
<b>SSR</b>				
Total power dissipation		P <sub>diss</sub>	600	mW
Ambient temperature range		T <sub>amb</sub>	-40 to +85	°C
Storage temperature range		T <sub>stg</sub>	-40 to +150	°C
Soldering temperature <sup>(1)</sup>	t = 10 s max.	T <sub>slid</sub>	260	°C
Isolation test voltage (for 60 s)		V <sub>ISO</sub>	5300	V <sub>RMS</sub>
Isolation resistance	V <sub>IO</sub> = 500 V, T <sub>amb</sub> = 25 °C	R <sub>IO</sub>	≥ 10 <sup>12</sup>	Ω
	V <sub>IO</sub> = 500 V, T <sub>amb</sub> = 100 °C	R <sub>IO</sub>	≥ 10 <sup>11</sup>	Ω
<b>OPTOCOUPLER</b>				
<b>INPUT</b>				
LED continuous forward current		I <sub>F</sub>	50	mA
LED reverse voltage	I <sub>R</sub> ≤ 10 μA	V <sub>R</sub>	5	V
<b>OUTPUT</b>				
Collector emitter breakdown voltage		BV <sub>CEO</sub>	30	V
Phototransistor power dissipation		P <sub>diss</sub>	150	mW

**Notes**

- Stresses in excess of the absolute maximum ratings can cause permanent damage to the device. Functional operation of the device is not implied at these or any other conditions in excess of those given in the operational sections of this document. Exposure to absolute maximum ratings for extended periods of the time can adversely affect reliability

<sup>(1)</sup> Refer to reflow profile for soldering conditions for surface mounted devices (SMD). Refer to wave profile for soldering conditions for through hole devices (DIP)

ELECTRICAL CHARACTERISTICS (T <sub>amb</sub> = 25 °C, unless otherwise specified)							
PARAMETER	TEST CONDITION	PART	SYMBOL	MIN.	TYP.	MAX.	UNIT
<b>SSR</b>							
<b>INPUT</b>							
LED forward current switch turn-on	I <sub>L</sub> = 100 mA, t = 10 ms		I <sub>Fon</sub>	-	0.7	2	mA
LED forward current switch turn-off	V <sub>L</sub> = ± 300 V		I <sub>Foff</sub>	0.2	0.6	-	mA
LED forward voltage	I <sub>F</sub> = 10 mA		V <sub>F</sub>	1.15	1.26	1.45	V
<b>OUTPUT</b>							
On-resistance AC/DC, pins 4 (±) to 6 (±)	I <sub>F</sub> = 5 mA, I <sub>L</sub> = ± 50 mA		R <sub>ON</sub>	12	20	25	Ω
Current limit	I <sub>F</sub> = 5 mA, t = 5 ms, V <sub>L</sub> = ± 6 V	LH1529AAC, LH1529AACTR	I <sub>limit</sub>	230	260	370	mA
		LH1529BB	I <sub>limit</sub>	170	210	250	mA
		LH1529BAC, LH1529BACTR	I <sub>limit</sub>	170	210	250	mA
Off-state leakage current	I <sub>F</sub> = 0 mA, V <sub>L</sub> = ± 100 V		I <sub>O</sub>	-	0.02	200	nA
	I <sub>F</sub> = 0 mA, V <sub>L</sub> = ± 350 V		I <sub>O</sub>	-	-	1	μA
Output capacitance pin 7 to pin 8	I <sub>F</sub> = 0 mA, V <sub>L</sub> = 1 V		C <sub>O</sub>	-	55	-	pF
	I <sub>F</sub> = 0 mA, V <sub>L</sub> = 50 V		C <sub>O</sub>	-	10	-	pF
Capacitance (input to output)	V <sub>ISO</sub> = 1 V		C <sub>IO</sub>	-	1.3	-	pF



<b>ELECTRICAL CHARACTERISTICS</b> ( $T_{amb} = 25\text{ }^{\circ}\text{C}$ , unless otherwise specified)							
PARAMETER	TEST CONDITION	PART	SYMBOL	MIN.	TYP.	MAX.	UNIT
<b>OPTOCOUPLER</b>							
LED forward current	$I_F = 10\text{ mA}$		$V_F$	0.9	1.2	1.5	V
Saturation voltage	$I_F = 16\text{ mA}$ , $I_C = 2\text{ mA}$		$V_{CEsat}$	-	0.7	0.5	V
Collector emitter dark current	$I_F = 0\text{ mA}$ , $V_{CE} = 5\text{ V}$		$I_{CEO}$	-	-	500	nA
Trickle current leakage	$I_F = 5\text{ }\mu\text{A}$ , $V_{CE} = 5\text{ V}$		$I_{CEO}$	-	-	1	$\mu\text{A}$
DC current transfer ratio	$I_F = 6\text{ mA}$ , $V_{CE} = 0.5\text{ V}$	LH1529AAC, LH1529AACTR	$CTR_{DC}$	33	100	-	%
		LH1529BB	$CTR_{DC}$	100	165	-	%
		LH1529BAC, LH1529BACTR	$CTR_{DC}$	100	165	-	%

**Note**

- Minimum and maximum values are testing requirements. Typical values are characteristics of the device and are the result of engineering evaluations. Typical values are for information only and are not part of the testing requirements

<b>SWITCHING CHARACTERISTICS</b> ( $T_{amb} = 25\text{ }^{\circ}\text{C}$ , unless otherwise specified)							
PARAMETER	TEST CONDITION	PART	SYMBOL	MIN.	TYP.	MAX.	UNIT
Turn-on time	$I_F = 5\text{ mA}$ , $I_L = 50\text{ mA}$	LH1529AAC, LH1529AACTR	$t_{on}$	-	2	3	ms
		LH1529BB	$t_{on}$	-	1.3	2.5	ms
		LH1529BAC, LH1529BACTR	$t_{on}$	-	1.3	2.5	ms
Turn-off time	$I_F = 5\text{ mA}$ , $I_L = 50\text{ mA}$	LH1529AAC, LH1529AACTR	$t_{off}$	-	0.6	3	ms
		LH1529BB	$t_{off}$	-	0.6	2.5	ms
		LH1529BAC, LH1529BACTR	$t_{off}$	-	0.6	2.5	ms



**PACKAGE DIMENSIONS** in millimeters

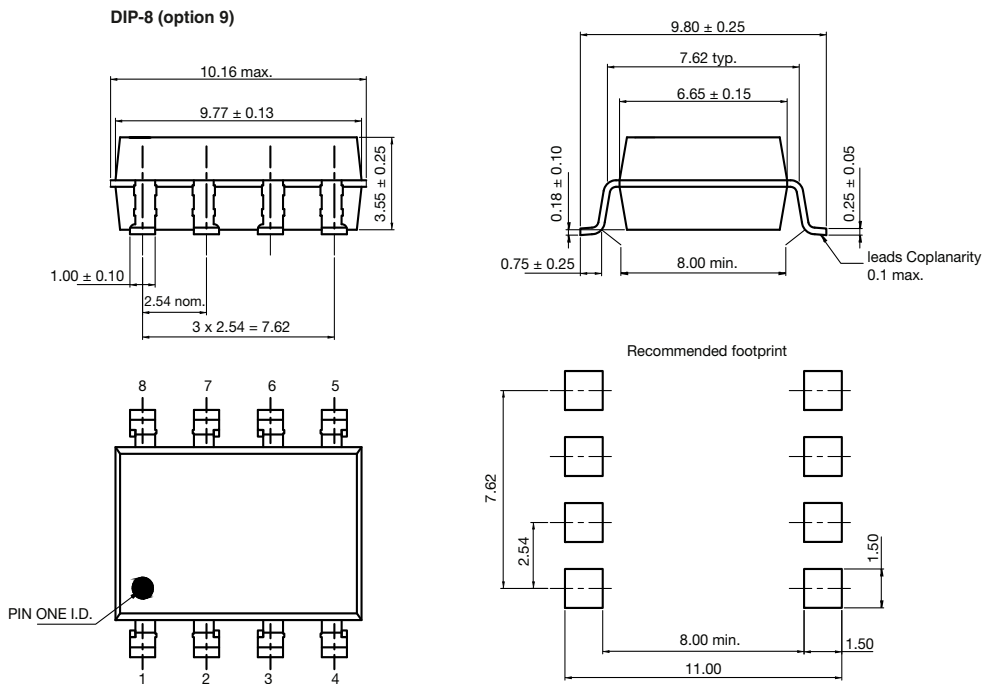
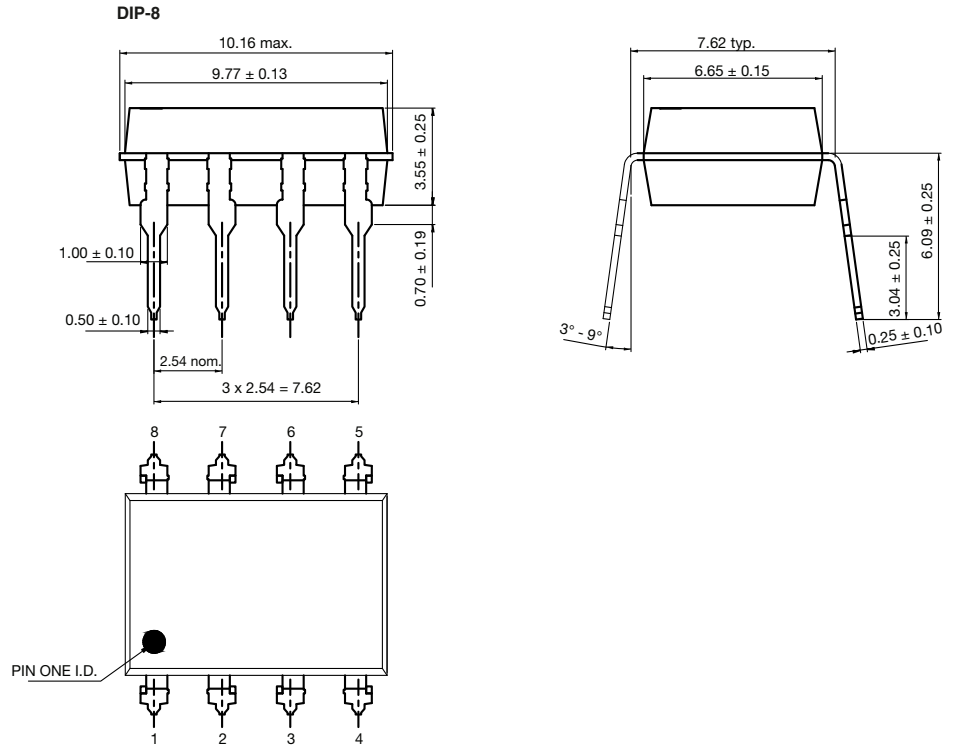

**PACKAGE MARKING** (example)

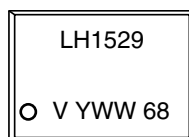

**Note**

- Tape and reel suffix (TR) is not part of the package marking



## Footprint and Schematic Information for LH1529

The footprint and schematic symbols for the following parts can be accessed using the associated links. They are available in Eagle, Altium, KiCad, OrCAD / Allegro, Pulsonix, and PADS.

Note that the 3D models for these parts can be found on the Vishay product page.

PART NUMBER	FOOTPRINT / SCHEMATIC
LH1529AAC	<a href="http://www.snapeda.com/parts/LH1529AAC/Vishay/view-part">www.snapeda.com/parts/LH1529AAC/Vishay/view-part</a>
LH1529AACTR	<a href="http://www.snapeda.com/parts/LH1529AACTR/Vishay/view-part">www.snapeda.com/parts/LH1529AACTR/Vishay/view-part</a>
LH1529BAC	<a href="http://www.snapeda.com/parts/LH1529BAC/Vishay/view-part">www.snapeda.com/parts/LH1529BAC/Vishay/view-part</a>
LH1529BACTR	<a href="http://www.snapeda.com/parts/LH1529BACTR/Vishay/view-part">www.snapeda.com/parts/LH1529BACTR/Vishay/view-part</a>
LH1529BB	<a href="http://www.snapeda.com/parts/LH1529BB/Vishay/view-part">www.snapeda.com/parts/LH1529BB/Vishay/view-part</a>
LH1529FPTR	<a href="http://www.snapeda.com/parts/LH1529FPTR/Vishay/view-part">www.snapeda.com/parts/LH1529FPTR/Vishay/view-part</a>
LH1529GP	<a href="http://www.snapeda.com/parts/LH1529GP/Vishay/view-part">www.snapeda.com/parts/LH1529GP/Vishay/view-part</a>
LH1529GPTR	<a href="http://www.snapeda.com/parts/LH1529GPTR/Vishay/view-part">www.snapeda.com/parts/LH1529GPTR/Vishay/view-part</a>

For technical issues and product support, please contact [optocoupleranswers@vishay.com](mailto:optocoupleranswers@vishay.com).

DIP

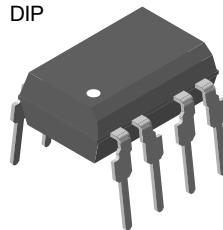

SMD

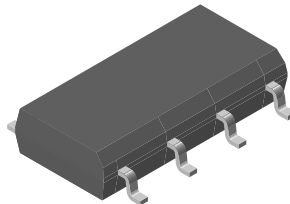
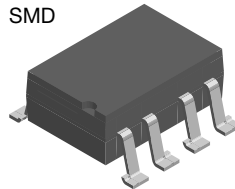



## Disclaimer

ALL PRODUCT, PRODUCT SPECIFICATIONS AND DATA ARE SUBJECT TO CHANGE WITHOUT NOTICE TO IMPROVE RELIABILITY, FUNCTION OR DESIGN OR OTHERWISE.

Vishay Intertechnology, Inc., its affiliates, agents, and employees, and all persons acting on its or their behalf (collectively, "Vishay"), disclaim any and all liability for any errors, inaccuracies or incompleteness contained in any datasheet or in any other disclosure relating to any product.

Vishay makes no warranty, representation or guarantee regarding the suitability of the products for any particular purpose or the continuing production of any product. To the maximum extent permitted by applicable law, Vishay disclaims (i) any and all liability arising out of the application or use of any product, (ii) any and all liability, including without limitation special, consequential or incidental damages, and (iii) any and all implied warranties, including warranties of fitness for particular purpose, non-infringement and merchantability.

Statements regarding the suitability of products for certain types of applications are based on Vishay's knowledge of typical requirements that are often placed on Vishay products in generic applications. Such statements are not binding statements about the suitability of products for a particular application. It is the customer's responsibility to validate that a particular product with the properties described in the product specification is suitable for use in a particular application. Parameters provided in datasheets and / or specifications may vary in different applications and performance may vary over time. All operating parameters, including typical parameters, must be validated for each customer application by the customer's technical experts. Product specifications do not expand or otherwise modify Vishay's terms and conditions of purchase, including but not limited to the warranty expressed therein.

Except as expressly indicated in writing, Vishay products are not designed for use in medical, life-saving, or life-sustaining applications or for any other application in which the failure of the Vishay product could result in personal injury or death. Customers using or selling Vishay products not expressly indicated for use in such applications do so at their own risk. Please contact authorized Vishay personnel to obtain written terms and conditions regarding products designed for such applications.

No license, express or implied, by estoppel or otherwise, to any intellectual property rights is granted by this document or by any conduct of Vishay. Product names and markings noted herein may be trademarks of their respective owners.